

LET THERE BE LIGHT

DIMLUX

EXPERT SERIES

User Manual



DIMLUX

® DimLux is a registered trademark of
airsupplies

DIMLUX EXPERT SERIES SPECIFICATIONS



315 WATT FULL SPECTRUM

- Available in 120V, 230V 277V
- Dim levels: Soft-Off, 165W, 205W, 245W, 280W, 315W, 345W, 380W
- Power consumption at 315W = 331W, 1.4A at 230V
- Power consumption at boost 380W = 399W, 1.7A at 230V
- System PPF at 380W = 706umol/s
- Weight 4.9kg (10.80lbs)
- Illumination surface:
at 315W = min 0.42m² (4.52ft²), max 1m² (10.76ft²)
at 380W = min 0.5m² (5.38ft²), max 1.2m² (12.91ft²)
- 50mm (2") connection for active extraction
- Dimensions 530x275x130mm (20.8"x10.8"x5.1")



630 WATT DUAL FULL SPECTRUM

- Available in 230V, 277V
- Also available in Nanotube version
- Dim levels: Soft-Off, 330W, 410W, 490W, 560W, 630W, 690W, 760W
- Power consumption at 630W = 662W, 2.7A at 230V
- Power consumption at boost 760W = 799W, 3.5A at 230V
- System PPF at 760W = 1,411umol/s
- Illumination surface:
at 630W = min 0.84m² (9.04ft²), max 2m² (21.52ft²)
at 760W = min 1m² (10.76ft²), max. 2.4m² (25.83ft²)
- 50mm (2") connection for active extraction
- Dimensions 675x275x130mm (26.5"x10.8"x5.1")
- Weight 6.3kg (13.88lbs)

Alpha Optics 98 reflectors for 250, 400 and 600watt E40 lamps.
*With the Maxicontroller (not included) more dim options possible

DIMLUX EXPERT SERIES SPECIFICATIONS



600 WATT EL UHF

- Dim levels: Soft-Off, 320W, 390W, 460W, 530W, 600W, 645W, 720W
- Power consumption at 600W = 630W, 2.7A at 230V
- Power consumption at boost 720W = 758W 3.27Amp at 230V
- System ppf at 720W = 1408umol/s
- Weight: 5.1kg (11.24lbs)
- Illumination surface:
at 600W = min. 0.78m² (8.39ft²), max 2m² (21.52ft²)
at 720W = min. 0.95m² (10.2ft²), max 2.4m² (25.8ft²)
- 50mm (2") connection for active air extraction
- Dimensions: 550mmx275mmx130mm (21.6"x10.8"x5.1")



1000 WATT DE EL UHF

- Available in 230V, 277V
- Also available in Nanotube version
- Dim levels: Soft-Off, 600W, 700W, 800W, 900W, 1000W, 1100W, 1200W
- Power consumption at 1000W = 1050W 4.5A at 230V
- Power consumption at boost 1200W = 1260W, 5.2A at 230V
- System PPF at 1200W = 2,470umol/s
- Illumination surface
at 1000W = min 1.4m² (15.06ft²), max 3.3m² (35.52ft²)
at 1200W = min 1.65m² (17.76ft²), max. 4m² (43.05ft²)
- 50mm (2") connection for active extraction
- Dimensions 675x275x130mm (26.5"x10.8"x5.1")
- Weight 6.3kg (13.88lbs)

Alpha Optics 98 reflectors for 250, 400 and 600watt E40 lamps.
*With the Maxicontroller (not included) more dim options possible

WHAT'S INCLUDED & COMPATIBLE BULBS

Unboxing

Your Dimlux fixture box will contain the following items:

1x Interlink cable (315&600W=2.0m 630&1000W=2.5m) 2x Eye bolt and nut (M6)
1x Power cord 1x Instruction manual

Extra Interlink cables are available in different sizes

0,6 m (24 in.)	1,0 m (40 in.)
1,5 m (60 in.)	2,0 m (80 in.)
2,5 m (100 in.)	3,5 m (140 in.)
5,0 m (200 in.)	10,0 m (400 in.)

Suitable lamps

⚠ Please ensure that the lamp has been burning for at least 5 minutes before you turning off the power. Short ON/OFF cycles can shorten the lifespan of the installed 315W lamp.

Dimlux Expert 315 Watt (dual);

- Dimlux Daylight 3k AGRO
- Dimlux Daylight 3k
- Dimlux Daylight 4k

Please ensure that only Dimlux branded 315w lamps are used in these fixtures as any other brand is not fully compatible and may fail after a short time.

Dimlux Expert 600 watt EL UHF;

- Philips Greenpower 600W EL UHF (400volt)
- Sylvania GroLux 600W 400Volt

Dimlux Expert 1000 watt EL UHF;

- 1000W Philips Master Greenpower EL DE

INSTALLATION

Mounting

There are indicators on the top rail of each fixture to help you mount the supplied fixing brackets in the correct place. The image below shows the locations for each different fixture.

- 1 Alpha 98 Optics 2 600W and 315W fixture 3 1000W and 630W fixture

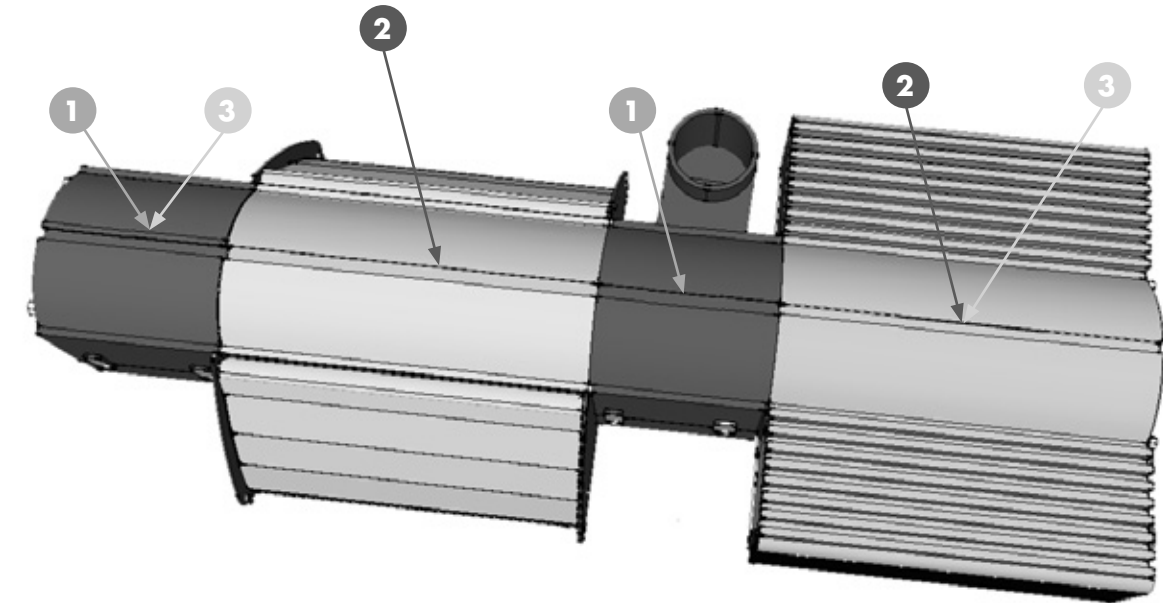

Installation

The Dimlux Expert series can be controlled with the Dimlux Maxi Controller or by using external switching gear (contactors, timers). Make sure that the contactors and timers are designed to match the load of the ballasts.



Maxi Controller

The Maxi Controller can control up to 160 Dimlux Expert fixtures at the same time. A switchboard, time delay timers, timers and relays (contactors) are no longer needed. The power cable can be directly plugged into a power socket. Lights on and off times, brightness and many more settings can be set with the Maxi Controller.

INSTALLATION

For up to 20 fixtures - connect to OUT1

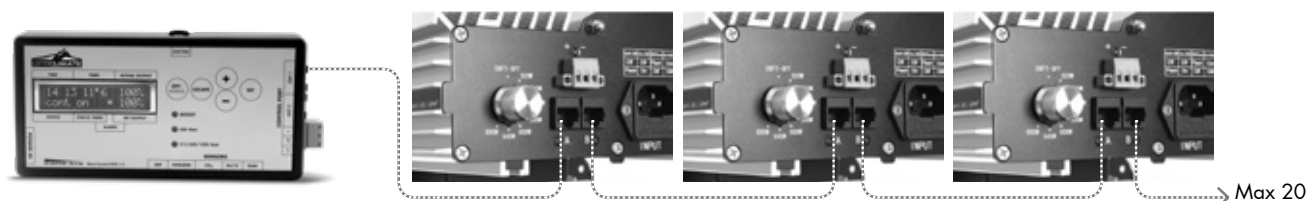

For more than 20 fixtures - divide equally between ports OUT1 and OUT2

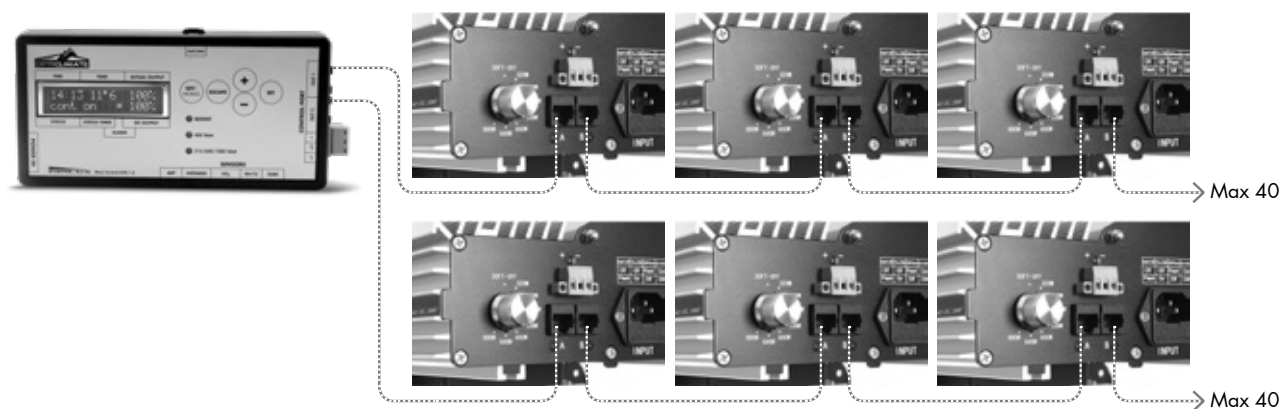

The Maxi Controller sends a signal to the fixtures to switch them on or off. There are 2 out ports on the maxi controller, each port can switch up to 80 fixtures using the oem interlink cables. Interlink cables are available in different lengths.

Please refer to the Maxi Controller manual for specific settings information.

For more than 80 fixtures - use a splitter and divide equally between out1 and out2

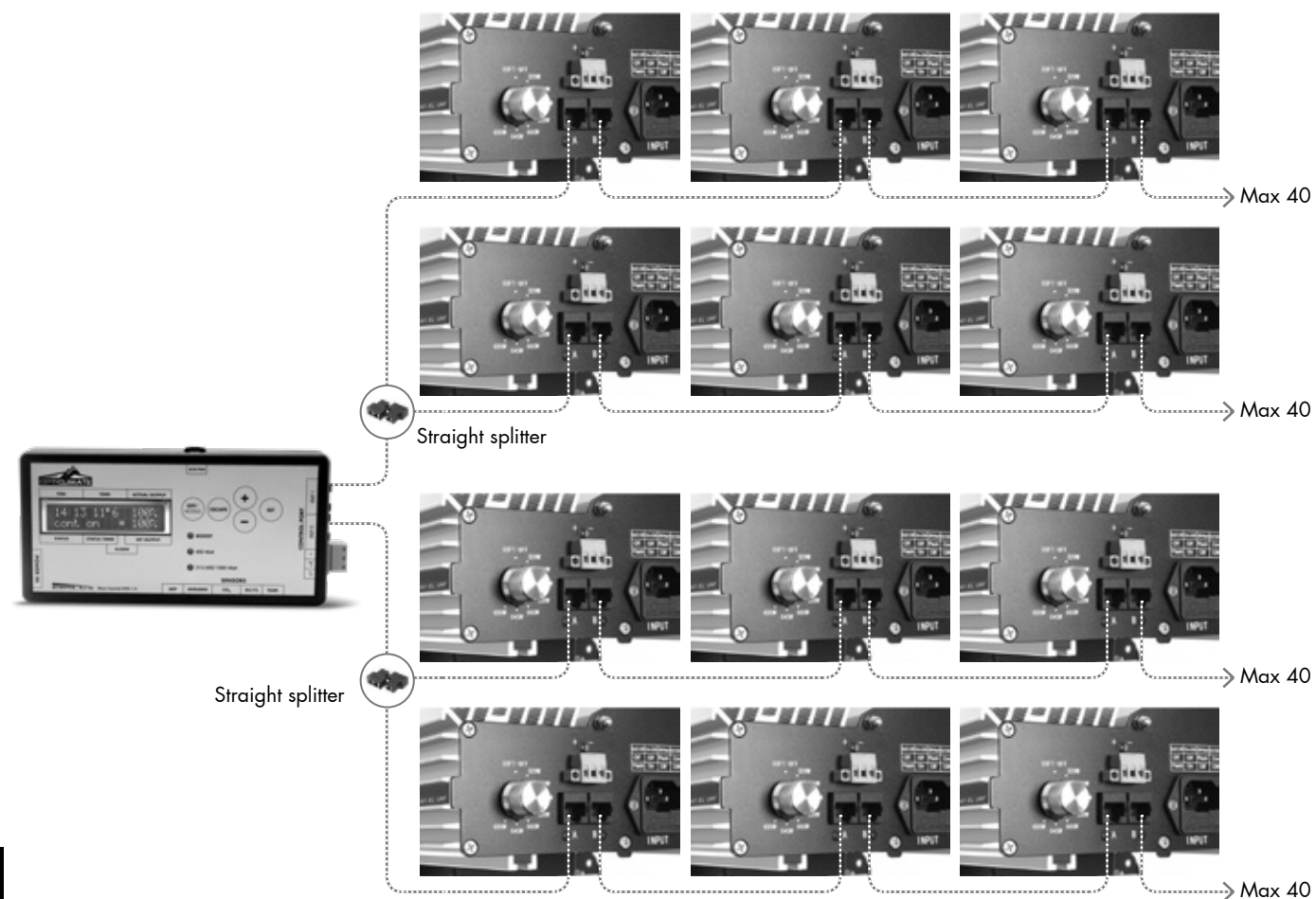

GENERAL USE

Air

The open reflector versions have openings in the top of the reflective portion so that no direct light can shine through. By natural convection, the heat will escape through these openings and cool the lamp.

There is also a 50mm (2") connection to connect active air removal to reduce the room temperature even more. The amount of air extracted through the 50mm (2") connection must be 200 m³/hour (120cfm) for each lamp. (no matter if it's a 315/600 or 1000 watt fixture)

Additional T-joints and 50mm tube can be supplied, the T-joints are 125-50-125mm (5"-2"-5"), 150-50-150mm (6"-2"-6") and 200-50-200mm (8"-2"-8").

Boosting and Cooling

Boosting light output will increase the temperature of the lamp. The lamp openings in the reflector, allow the lamp temperature to operate at its optimum level. Without this indirect cooling, the lamp efficiency decreases. When hot air is actively extracted, the efficiency of the lamp will slightly increase. The lamp is not cooled too much because the reflector is constructed in such a way that the air is not removed at the lamp itself but around it.

Optical Design

The main goal in designing the reflector was to achieve the highest efficiency (light output) possible. It's designed according to the SBCS (Single Bounce Clear Sight) principle which means that each light beam reflects only one single time in the reflector and then goes out directly (Single Bounce). After reflection, the beam is not hindered by the lamp or other parts (Clear Sight). The design from the reflector is optically perfect so that no hammered or textured pattern is needed to spread hotspots. Hammered or textured reflective reflectors are made to improve uniformity and create undesirable multiple reflections inside the reflector and cause internal reflections from the reflector to the lamp causing a decrease in efficiency. These techniques used in our reflector combined with the use of Miro Silver mirror will provide unparalleled results.

Reflector Adjustment

The reflector has adjustable side-reflectors with 2 positions, a wide position and a deep position. The "wide" position gives an overlap in a multi reflector set-up. The footprint ratio is 0.8:1. When the reflector is next to walls or in a square one lamp room, the adjustable side-reflector is set to the "deep" position and the footprint image is 1:1.

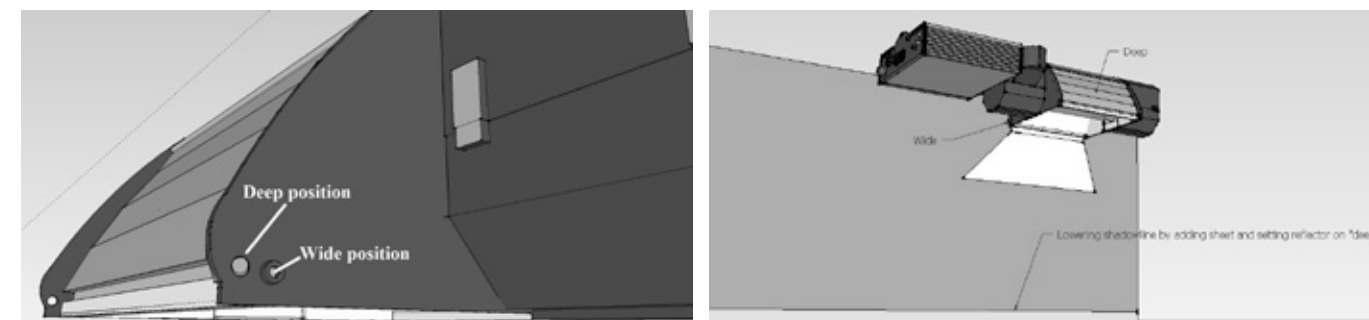

When the side-reflector is moved to the outer position, the reflector is in "deep" position, when moving the side-reflector towards the lamp the reflector is in "wide" position.

Add-on reflectors (wings)

The full fixture or separate Alpha Optics reflector can be fitted with loose add-on reflectors. The reflectors that are adjacent to a wall or corner can be equipped with these wings to minimise reflection losses to the wall. These wings have a hammered texture because the angle of reflection is so large that the SBCS principle is maintained. Reflectors next to a wall require one wing, reflectors in a corner can be fitted with 2 wings and reflectors in the middle of a room require no wings. Add-on reflectors minimise wall losses and give more light to the surroundings from the illuminated grid.

The add-on reflectors are available as overlapping and non overlapping models. The overlapping models are used in a multi row set-up and the non overlapping models are used when there is only one row of reflectors in the room.

How high?

There is a very simple and unique way to determine the minimum height of the reflector. Rule of thumb is that the shortest distance from reflector to crop is minimum half the distance between the other reflectors in a multi lamp set-up. It doesn't matter if the lamp is 400 watt or 1000 watt. A 1000 watt lamp naturally illuminates a larger surface than a 400 watt lamp, automatically increasing distance between reflector and crop.

A reflector hanging lower than calculated will increase hotspots and decrease uniformity. Lower is not better!

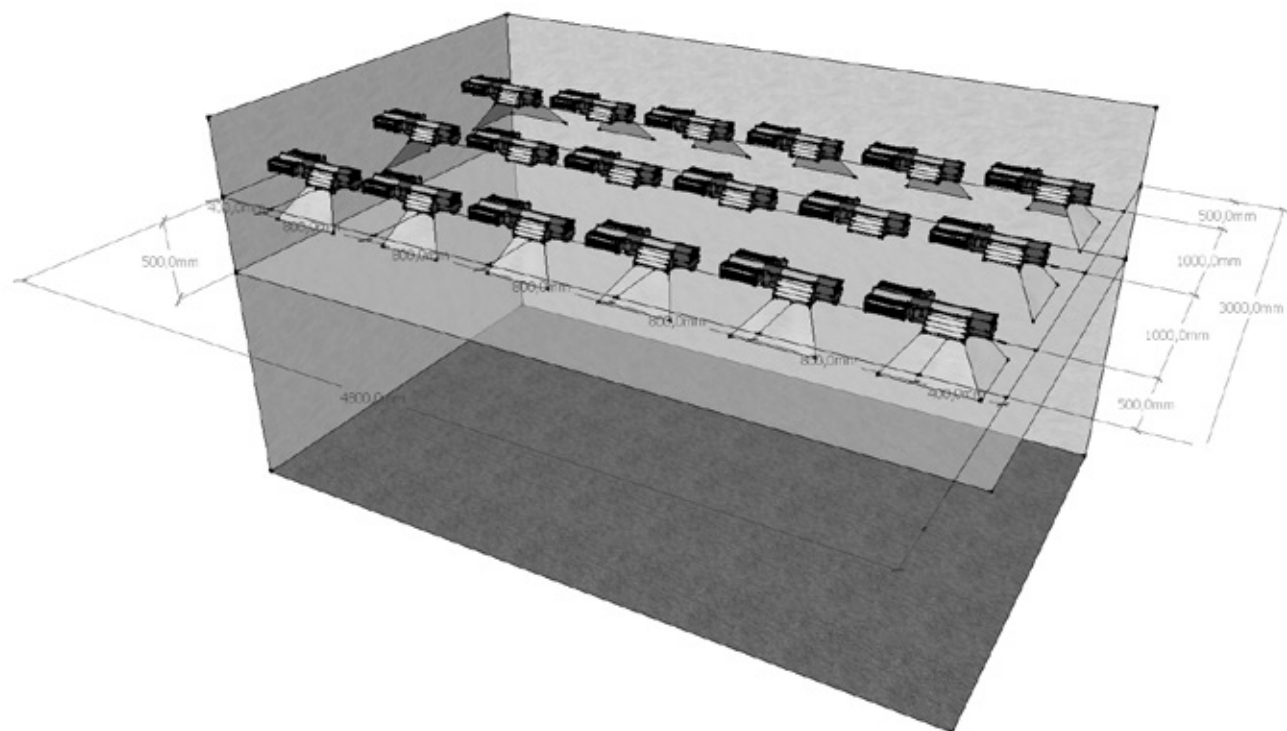

Typical 600 watt layout

Distance

Distance between reflectors depends on the lamp, not the reflector. Maximum light output for most crops is 1500 $\mu\text{mol}/\text{m}^2/\text{s}$.

Example:

The 600 watt EL UHF lamp output is 1190 μmol , with boost it's almost 1409 $\mu\text{mol}/\text{m}^2/\text{s}$. There will be some light loss due to reflections loss from walls and reflector. Because boost gives more efficiency with cooled lamps and using add-on wings the light output will be almost the same. 1409 $\mu\text{mol}/\text{m}^2/\text{s}$ is almost the limit when illuminating 1m² with 1 reflector and a 600 watt EL UHF lamp. 0.8 m² is the maximum.

Display indication on dimlux ballast equipment

Each Dimlux fixture has its own self diagnosis system. A display on the side of each unit shows error and status information.

Soft-off	On-DB	Off-Rem	On-Rem	Ignite	HVP	LVP	HTP	Open	Short	EOL
F-Flash	F-On	A-Flash	A-On	1-Strobo	2-On	3-On	4-On	5-On	6-On	7-On

Status

- F-Flash = Soft off** The ballast is off because the dim button is on soft-off.
- F-on = On-DB** The ballast is on, no maxi controller detected.
- A-Flash = Off remote** The ballast is off by maxi controller.
- A-on = on remote** The ballast is on by maxi controller.
- 1-strobo = Igniting** The ballast is igniting the lamp.

Error

- 2-On = HVP** Error. The input voltage is too high.
- 3-On = LVP** Error. The input voltage is too low.
- 4-On = HTP** Error. The ballast is too hot.
- 5-On = Open** Error. Open contact or lamp failure.
- 6-On = Short** Error. Short in lamp circuit or lamp failure.
- 7-On = EOL** Error. Replace lamp.

Lamp replacement

⚠ Always wear gloves when replacing lamps to avoid leaving any residue on the new lamp which will affect performance

The Dimlux 315W CDM lamps have a bayonet connector. When installing a new lamp ensure that the two pins are lined up with the holes in the fitting, then push and turn to lock the lamp in place.

The 1000 watt DE lamp has 2 slide fittings.

The 600w Dimlux fixtures use 600w lamps with E40 'screw in' fittings. Simply unscrew the old lamp and screw in the new one, making sure that it is screwed in tight to avoid any performance issues.



1000W LAMP REPLACEMENT

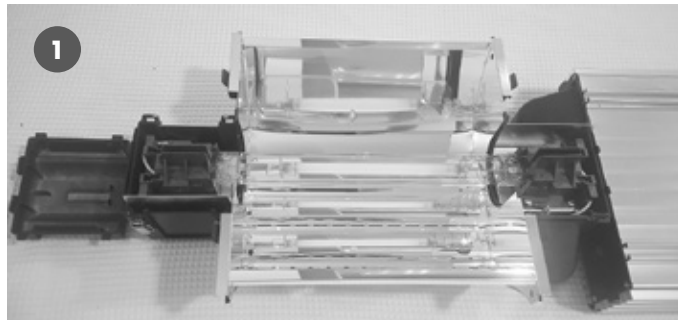

Open and remove both covers to expose lamp fittings

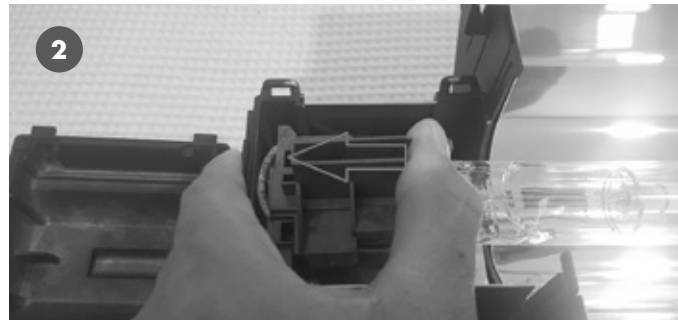

Slide both fittings fully open as shown

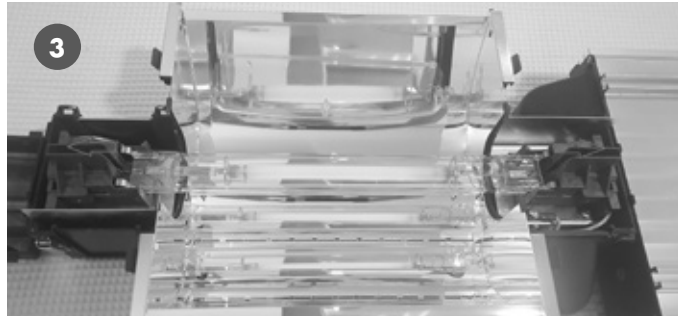

Make sure both sliders are in the fully-open position.

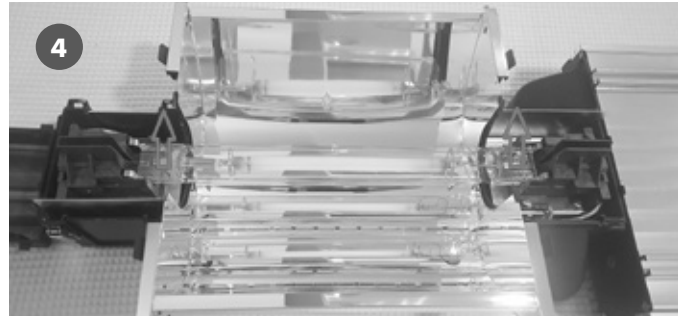

Remove the lamp

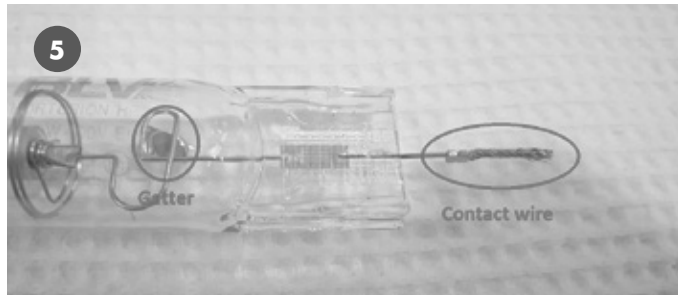

Before placing the new lamp, make sure the contact wire is straight, the getter is on the ballast side and the text on the lamp is facing out.

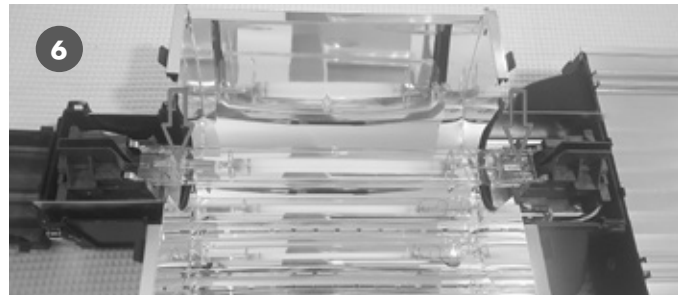

Insert lamp and push into place

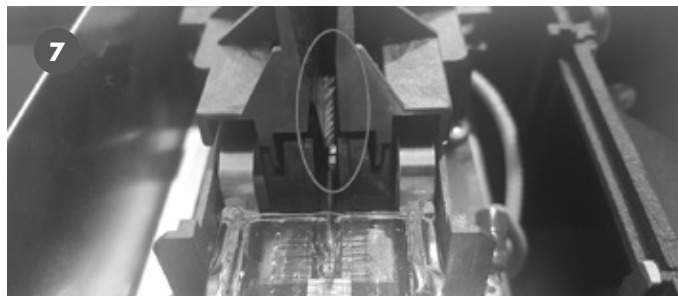

Make sure the contact wire from the lamp is straight between the contact plates inside the fitting

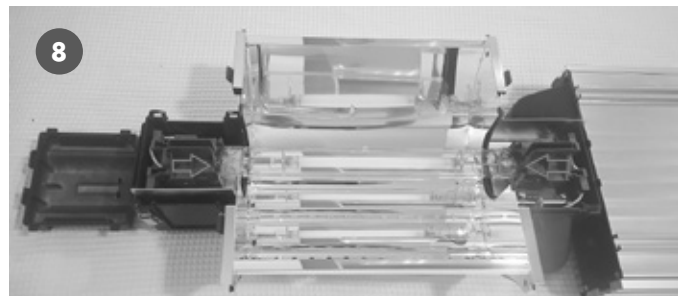

Slide the fittings firmly inwards



Make sure the fitting is fully closed

⚠ Test the complete fixture.

REFLECTOR REPLACEMENT

⚠ Remove Lamp(s) before replacement

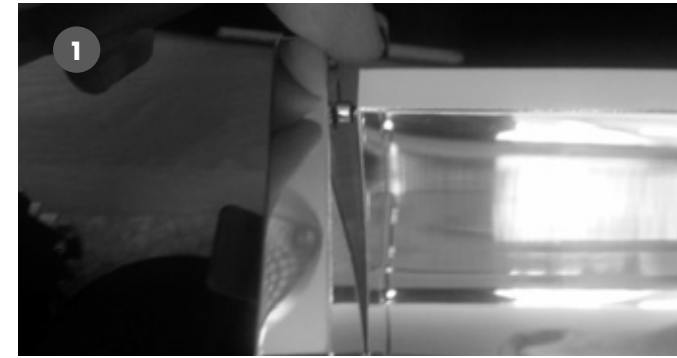

Bend open side to unlock

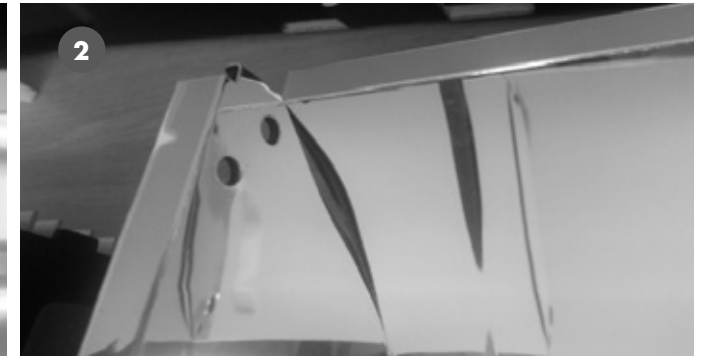

Open reflector all the way

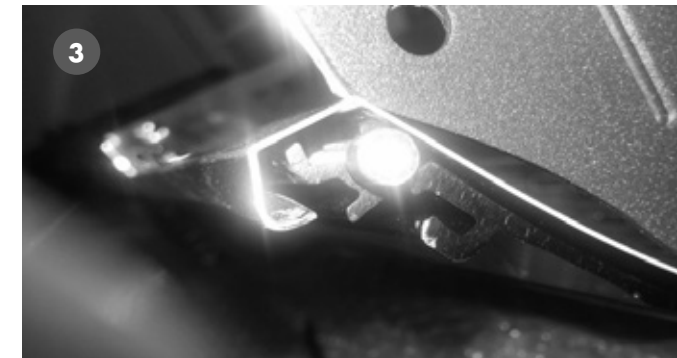

Pry end of reflector open

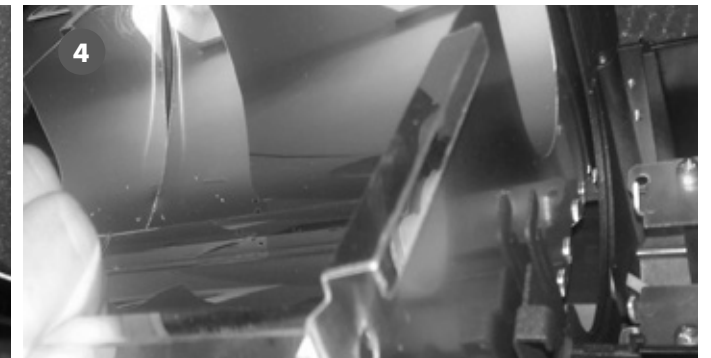

Lift reflector straight out

- Always dispose of old reflectors, do not re-use as performance will be severely affected.
- To install your new reflector please follow the above instructions in reverse order.



Dimlux B.V.
Amsterdam, the Netherlands
www.dimlux.nl

MADE IN HOLLAND

® **DimLux** is a registered trademark of
airwipplia